

# Blackjack<sup>®</sup> P-RACK

State-of-the-art hyper-optimized video management platform designed for ease, speed and efficiency.

Blackjack P-Rack — Up to 600Mbps.

Linux OS			Windows OS		
DW-BJP1U-LX	DW-BJP2U-LX	DW-BJPR2U-LX	DW-BJP1U	DW-BJP2U	DW-BJPR2U



DW-BJP1U-LX  
DW-BJP1U



DW-BJP2U-LX  
DW-BJP2U  
DW-BJPR2U-LX  
DW-BJPR2U

Default Login Information for DW Spectrum

Username: <b>admin</b>	Password: <b>admin12345</b>
------------------------	-----------------------------

Default login information for the server's OS

Username: <b>dwuser</b>	Password: <b>Dw5pectrum</b>
-------------------------	-----------------------------

## WHAT'S IN THE BOX

P-Rack™ server		1	Keyboard and mouse		1 set	Rail kit		1 set
Quick start guide		1	Power cable		1 set			

**NOTE:** Download all your support materials and tools in one place.

1. Go to: <http://www.digital-watchdog.com/support-download/>.
2. Search your product by entering the part number in the 'Search by Product' search bar. Results for applicable part numbers will populate automatically based on the part number you enter.
3. Click 'Search'. All supported materials, including manuals, Quick Start Guides (QSG), software and firmware will appear in the results.



**Attention:** This document is intended to serve as a quick reference for initial setup. See the DW Spectrum full manual for more information on features and functionality.

## BLACKJACK<sup>®</sup> P-RACK™ HARDWARE

Front 1U models

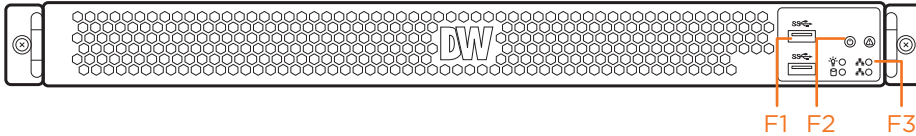

- F1 2x USB 2.0 ports
- F2 Power button
- F3 HDD status LED

Front 2U models

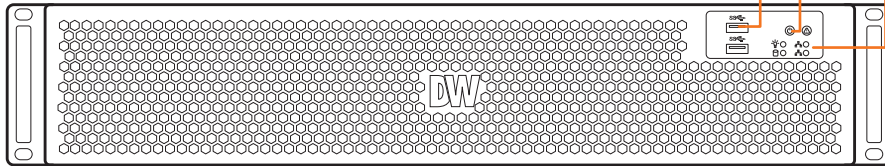

- B1 Power input
- B2 Keyboard port (PS2 type)
- B3 USB 2.0 ports
- B4 Serial ports (Not used)
- B5 Network ports
- B6 USB 3.0 ports
- B7 Audio ports
- B8 DVI-I output
- B9 True HD output

Back 1U models

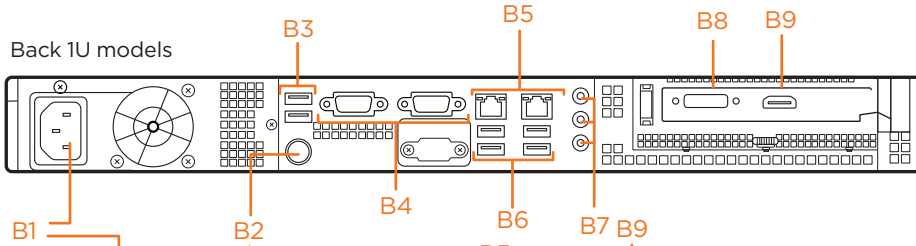

Back 2U models

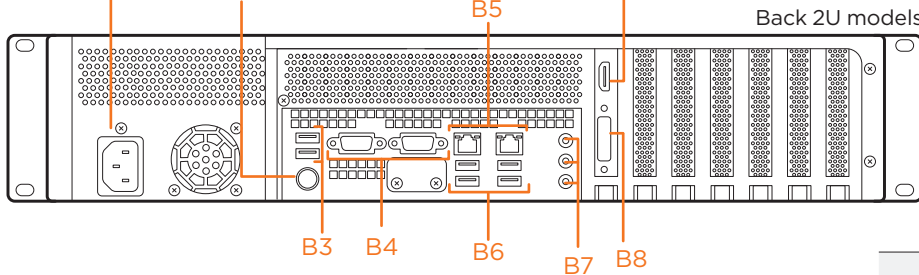

### Default login information for DW Spectrum

Username: <b>admin</b>	Password: <b>admin12345</b>
------------------------	-----------------------------

### Default Login Information for the server's OS

Username: <b>dwuser</b>	Password: <b>Dw5pectrum</b>
-------------------------	-----------------------------

## SPECIFICATIONS

PART NUMBER	DW-BJP1UXT	DW-BJP2UXT	DW-BJPR2UXXT
Included IP licenses	4	4	4
Form factor	Rackmount	Rackmount	Rackmount
Operating system	Windows 11	DW-BJP1UXT	DW-BJPR2UXXT
	Linux Ubuntu OS	DW-BJP1UXT-LX	DW-BJPR2UXXT-LX
	OS on SSD	150GB SSD	150GB SSD
CPU	Intel i5 processor	Intel i7 processor	Intel i7 processor
Memory	16GB	16GB	16GB
Ethernet port	1x 1 Gigabit Ethernet port (RJ45) 1x 2.5 Gigabit Ethernet port (RJ45)	1x 1 Gigabit Ethernet port (RJ45) 1x 2.5 Gigabit Ethernet port (RJ45)	1x 1 Gigabit Ethernet port (RJ45) 1x 2.5 Gigabit Ethernet port (RJ45)
System	Max video storage rate (Mbps)	360 Mbps	600 Mbps
	Maximum HDD	3 x 3.5 SATA HDD	6 x 3.5 SATA HDD
	Maximum storage	60TB	120TB
	RAID options	N/A	N/A
Storage	RAID options	N/A	RAID5
	USB interface	Yes	Yes
	Outputs	True HD output or DVI	True HD output or DVI
	Video card	GeForce 210 1024MB	GeForce 210 1024MB
Video-out	Resolution	Max 2560 x 1600 @ 60Hz	Max 2560 x 1600 @ 60Hz
	Pre-loaded VMS software	DW Spectrum	DW Spectrum
Remote clients	Cross-platform - Windows, Linux Ubuntu and Mac	Cross-platform - Windows, Linux Ubuntu and Mac	Cross-platform - Windows, Linux Ubuntu and Mac
Keyboard and mouse	Included	Included	Included
Rail kit	Included	Included	Included
Power supply	300W**	400W**	400W**
Operating temperature	41°F-104°F (5°C-40°C)	41°F-104°F (5°C-40°C)	41°F-104°F (5°C-40°C)
Operating humidity	20-90% RH	20-90% RH	20-90% RH
Dimension (WxDxH)	17.1875 x 20.065" x 1.75" (437 x 510 x 44.45 mm)	17.3" x 21.9" x 3.5" (439.3 x 557.1 x 88.9 mm)	17.3" x 21.9" x 3.5" (439.3 x 557.1 x 88.9 mm)
Other certification	FCC, CE, NDAA, TAA	FCC, CE, NDAA, TAA	FCC, CE, NDAA, TAA
Warranty	5 year limited	5 year limited	5 year limited

\* Available at time of initial order only / \*\* UPS recommended

Specifications and components mentioned are subject to change without notice.

## SETTING UP THE SERVER

### STEP 1: Connect external devices, power and network.

1. Connect a monitor, USB keyboard, USB mouse and network cable to one of the Ethernet ports (B5 on the diagram). Configure the camera's network first, then configure the server's local network.
2. Connect the server to an appropriate power source. UPS system rated for 750VA or higher per PSU is recommended for the 1U P-RACK. UPS system rated for 1000VA or higher per PSU is recommended for the 2U P-RACK.
3. Power up the server, if it does not turn on automatically by pressing the power button on the front (F2 on the diagram).  
\* Connecting the power cable to the live power source may turn on the server automatically.

#### DW-BJP1U Hardware

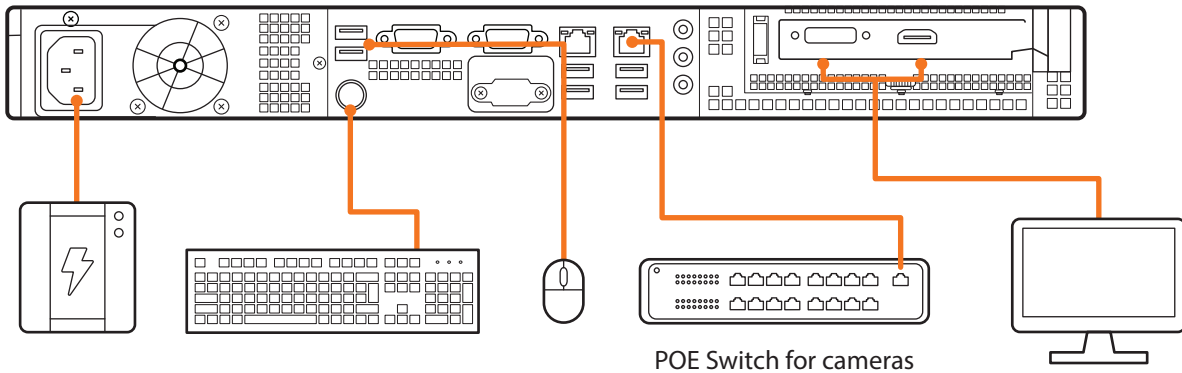

#### DW-BJP2U and DW-BJP2RU Hardware

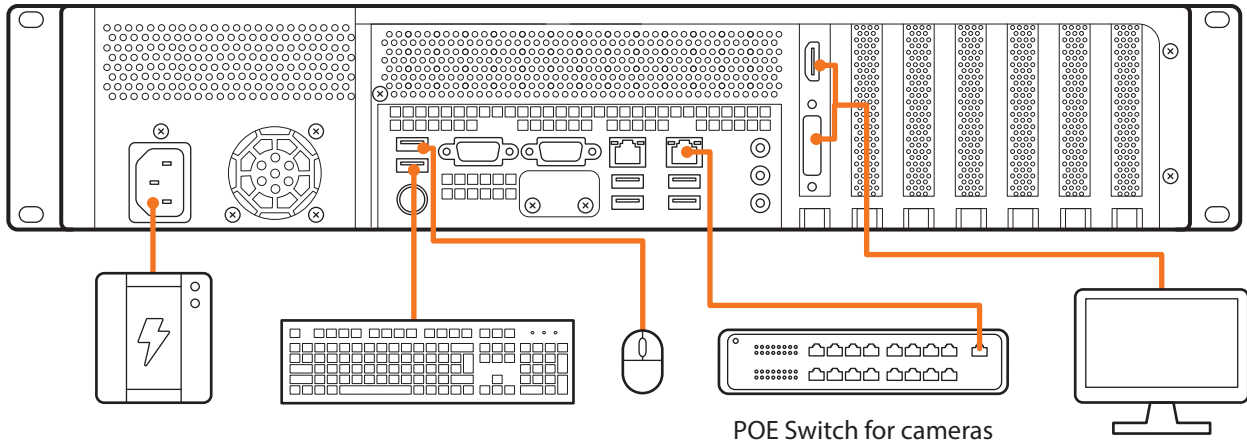

### STEP 2: Configure date and time

#### Windows OS:

1. Double-click on the **Date and Time** icon on the desktop.
2. The default time zone is UTC-08:00 Pacific Time. Click **Change time zone...** to change to the correct time zone.



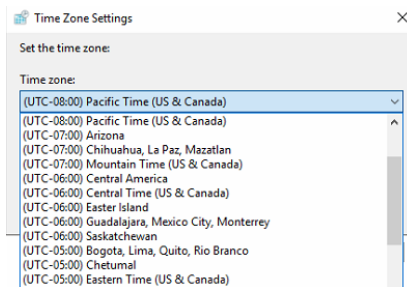

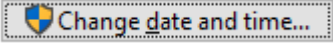
3. Click **OK** after selecting the correct time zone.
4. Click **Change date and time...** to update the date and time if incorrect.  **NOTE:** Verify the time zone before updating the date and time. Time may show 2 or 3 hours off due to an incorrect time zone.

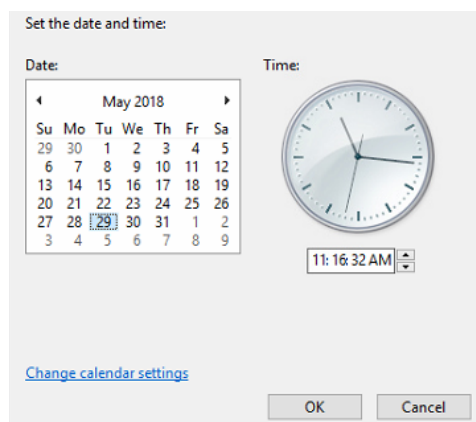

5. Press **OK** after adjusting to the correct date and/or time. Press **OK** to close the date and time when done.

## Linux OS:

1. Open Settings and go to Details > Date & Time.

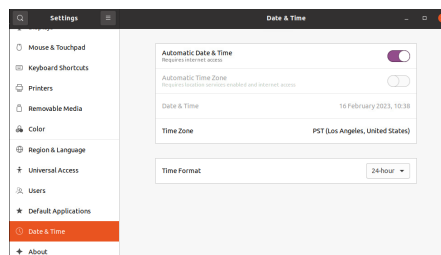
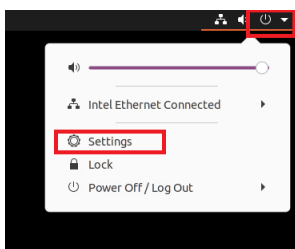

2. Turn OFF Automatic Date & Time and Automatic Time Zone

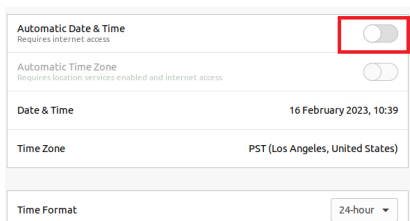

3. Click Date & Time and set the correct date and time.

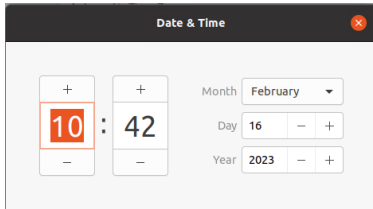

4. Click Time Zone and set it to the correct Time zone. (Type one of the largest cities in the time zone).

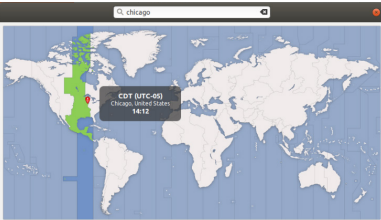

5. Close Settings.

### STEP 3: Configure network

Please have the following information ready before starting the network configuration.

	Camera network	Local network (LAN)
IP address		
Subnet mask / Netmask		
Default gateway / Gateway	N/A	
DNS servers	N/A	

\* The camera and local network cannot be on the same network.

**NOTE** The Blackjack server's network settings are set to DHCP by default.

**NOTE** If you are not sure what information to enter, contact your Network Administrator or Internet Service Provider.

### Windows OS:

1. Double-click on **Network Connections** on the desktop.
2. Right-click **Ethernet** (connected) and click **Properties**.

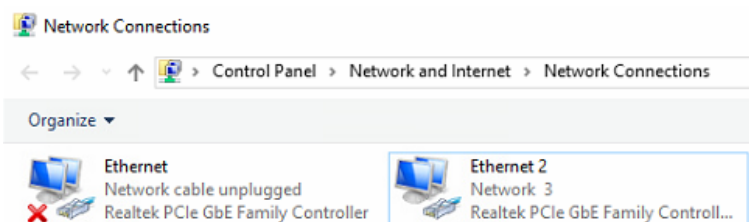

3. Select **Internet Protocol Version 4 (TCP/IPv4)** and click **Properties**.

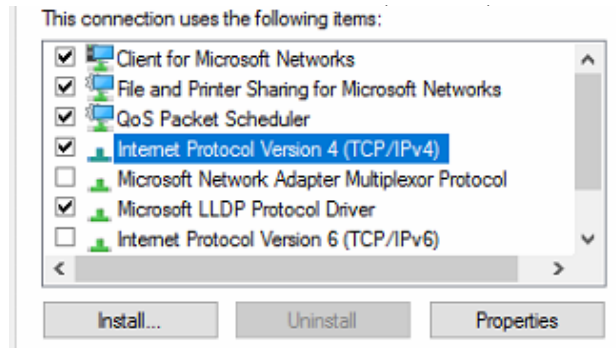

4. Click the **Use the following IP address:** radio button – **Use the following DNS server addresses:** will be selected automatically.
5. Enter the local network's IP address, subnet mask, and preferred and alternate DNS server addresses.
6. Click **OK** to close the window and again for the properties window.

**NOTE** It must be the same network as the cameras and must not be the same network as the local network. Contact your network administrator for more information.

## Local Network

7. Right-click on the **Ethernet** (Network cable unplugged) and click **Properties**.
8. Select **Internet Protocol Version 4 (TCP/IPv4)** and click **Properties**.

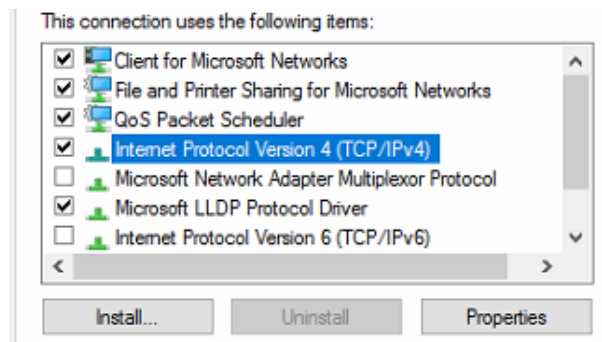

9. Click the **Use the following IP address:** radio button – **Use the following DNS server addresses:** will be selected automatically.
10. Enter the IP address and subnet mask of the camera network. Leave the default gateway and preferred and alternate DNS server fields blank.
11. Click **OK** to close the window and again for the properties window.
12. Connect a network cable to Ethernet port B5 (2.5G LAN) on the rear panel diagram to activate the local network connection.
13. Close the network connections window.

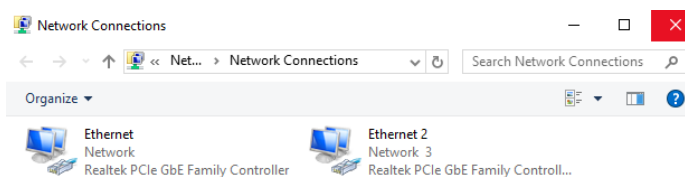

## Linux OS:

1. Open Settings > Network

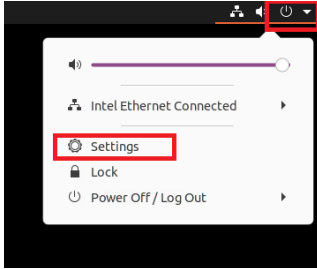

2. Click Setting of the Realtek Ethernet.

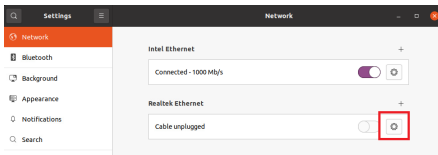

3. Change to Manual, then enter Address, Netmask, and Gateway.  
\* Do not enter Gateway information if there is no Gateway in this network.
4. Click Apply to save.

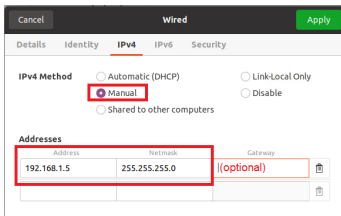

5. Restart the connection by switching it OFF and then turning it ON. If the connection is off, connect the network cable.

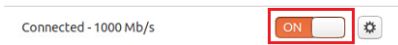

6. Click Settings of the Intel Ethernet.
7. Change the settings to access the Internet and remote access from a local network.
8. Click Apply to save.
9. Restart the connection by switching it OFF and then turning it ON. If the connection is off, connect the network cable.

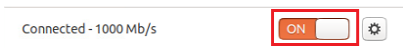

**NOTE** If you are not connecting to the Blackjack® from the same network, you may be required to perform port forwarding on your router to access the server. Contact your Network Administrator or Installer for additional information

## CONFIGURE CAMERAS USING DW IP FINDER

Refer to the camera's QSG to configure any DW IP camera's IP address using DW IP finder.

## SETTING UP DW SPECTRUM MEDIA SERVER

Login: **admin**  
Password: **admin12345**

### STEP 1: Login from the Blackjack® server



1. Open the DW Spectrum client.
2. Click on the pre-configured server.
3. If it does not log in automatically, enter the default password and click **Connect**.

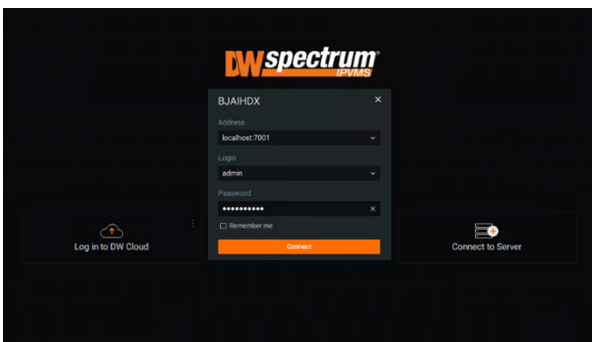
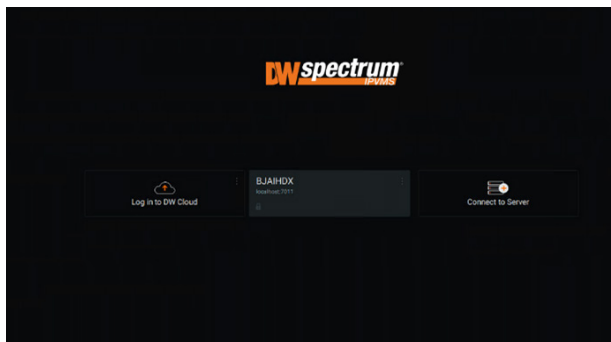

### STEP 2: To rename the server

1. Right-click on the server name in the resource list on the left side and click **Server Settings...**
2. Enter the new server name in the name field and click **OK**.

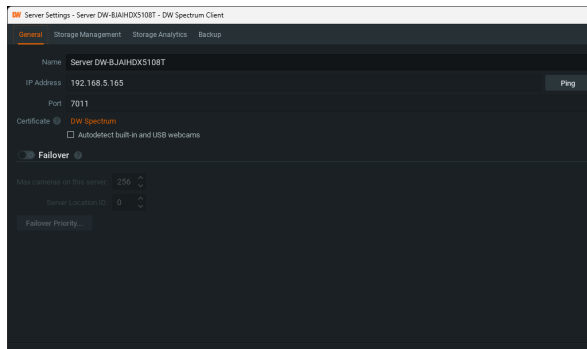

### STEP 3: To check for updates

1. Click the **main menu icon** in the upper-left corner of the DW Spectrum window, and click **System Administration...**
2. Click the **Updates** tab. If the system needs to be updated, click on the **Update** button.



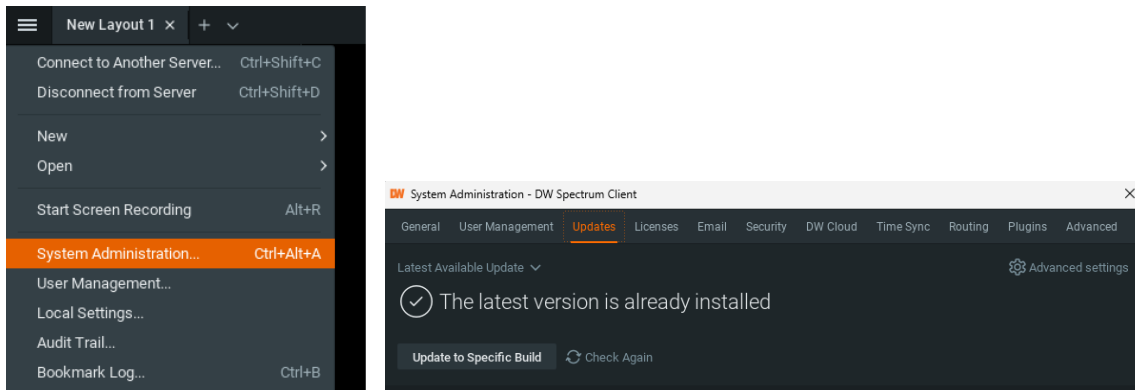

\* If the latest version is already installed, the message “The latest version is already installed” will be visible at the top.

3. Click **OK** when the update is complete.

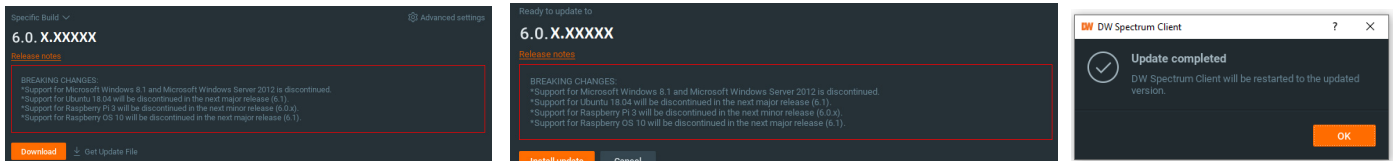

## STEP 4: Activate licenses

**NOTE:** An active Internet connection is required.

1. Click the **main menu icon** in the upper-left corner of the DW Spectrum window, and click **System Administration...**
2. Click the **Licenses** tab. Enter the license key and click **Activate License**.

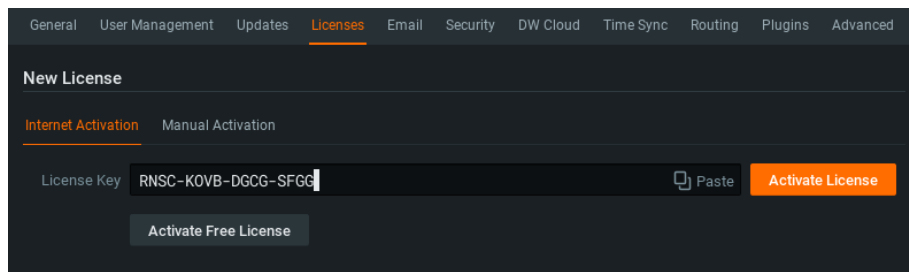

\* Click **Activate Free License** to use a free, four-channel license for 30 days.

3. Click **OK** when all necessary license keys are activated.

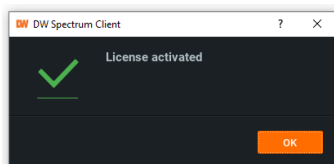

## STEP 5: Configure recording

1. Right-click a camera in the resource list on the left side and click **Camera Settings...**
2. Click the **Recording** tab.

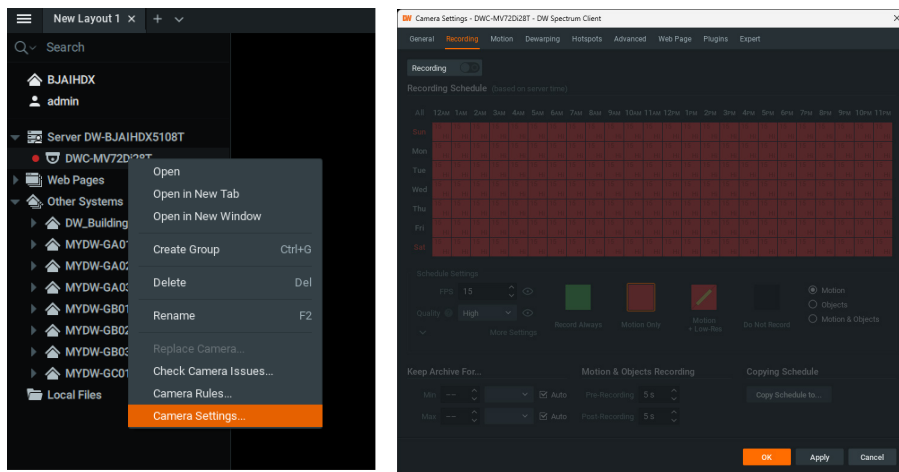

3. Click the **Recording** toggle to activate recording for that camera.
4. Set quality, FPS, and recording type.
5. Click and drag over the recording schedule to apply the settings to any number of days and times.

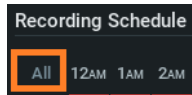
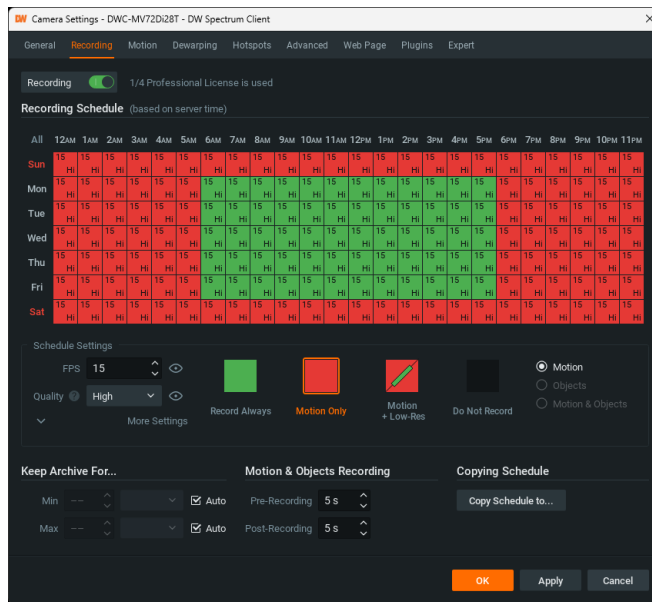

\* Click **All** to apply the recording settings to the entire schedule.

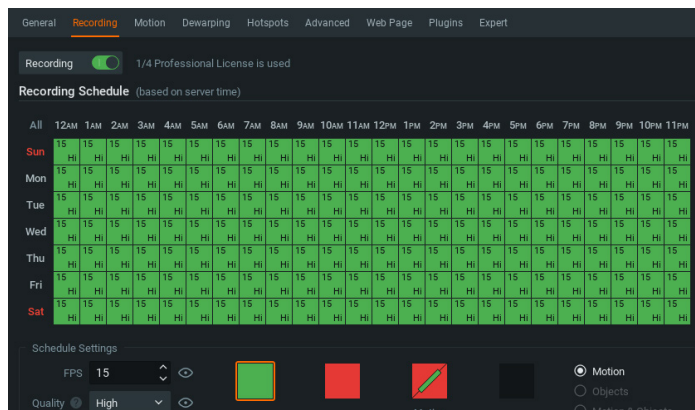

6. Click **OK** when the necessary recording schedule is set. A red circle will appear next to the camera in the resource list.

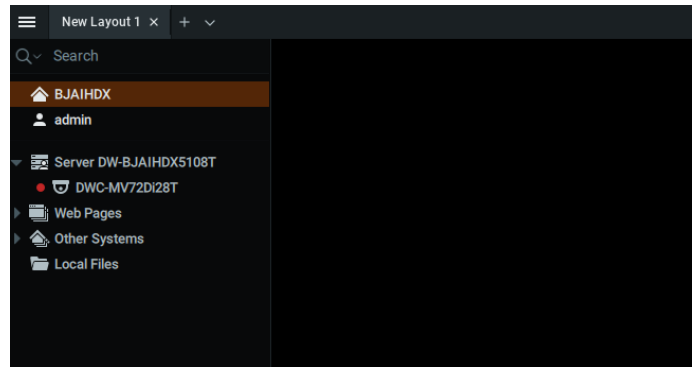

**NOTE:** A Recording License is required to allow a camera to record to the archive.

## STEP 6: Backup database

1. Click the **main menu icon** in the upper-left corner of the DW Spectrum window, and click **System Administration...**
2. Click the **Advanced** tab. Click **Create Backup...**
3. Select the location to save the database, and enter a name for the backup file. Click **Save**.

\* Creating a database backup to external storage before and after every update is strongly recommended.

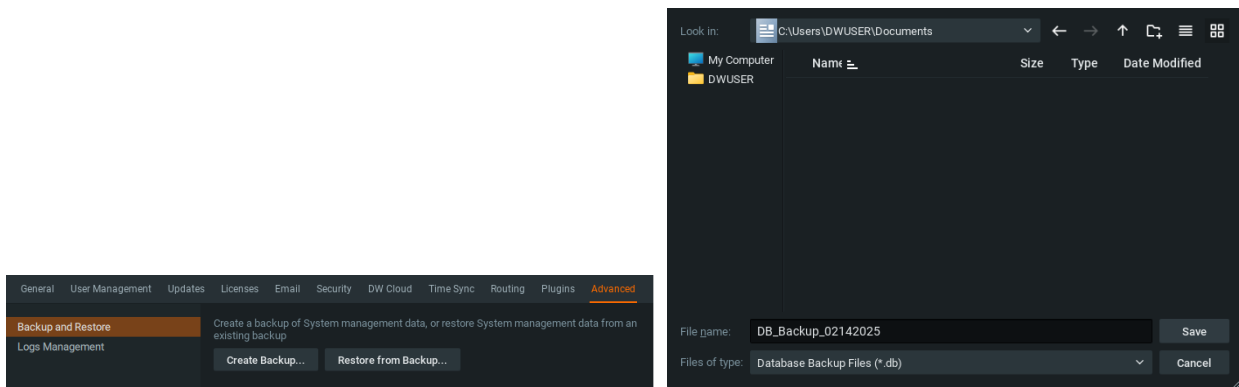

**NOTE:** More information and instructions are available in the DW Spectrum® user manual.

**NOTE:** This products is covered by one or more claims of the HEVC Patents listed at [patentlist.accessadvance.com](http://patentlist.accessadvance.com).



# TROUBLESHOOTING TIPS

Problem	Possible solutions
A camera or other device is not automatically discovered.	<ol style="list-style-type: none"> <li>1. The device must be on the same local network as the media server.</li> <li>2. The device must be compatible with DW Spectrum. Refer to the full list of supported cameras on <a href="http://digital-watchdog.com">digital-watchdog.com</a></li> <li>3. Update the device with the latest firmware.</li> <li>4. Ensure ONVIF is enabled on the device.</li> <li>5. Add the camera manually.</li> <li>6. Reboot the server after installation. Allow up to 2 minutes for the server to detect all supported devices.</li> </ol>
Slow video	<ol style="list-style-type: none"> <li>1. The same camera(s) could be accessed by multiple clients simultaneously.</li> <li>2. Check network speed.</li> </ol>
Device appears disconnected	<ol style="list-style-type: none"> <li>1. Ensure the username and password are correct in device settings.</li> <li>2. Click the ping button in device settings to ensure the camera is connected to the network.</li> <li>3. Reboot or restore the device to the factory default if its web page is available.</li> <li>4. Update the device with the latest firmware.</li> <li>5. The device must be on the same local network as the media server.</li> <li>6. Ensure ONVIF is enabled on the device.</li> <li>7. The user may not have the necessary permissions to view that device.</li> </ol>
Cannot view archived video	<ol style="list-style-type: none"> <li>1. Ensure there is an active network connection between the client and server.</li> <li>2. The user may not have the necessary permissions to view the archive from that device.</li> <li>3. The camera may be set to a recording mode that does not record video for the selected time and environment.</li> <li>4. Check the log on the media server to ensure the device did not unexpectedly disconnect.</li> </ol>
"Unauthorized" message on a device	<ol style="list-style-type: none"> <li>1. Ensure the username and password are correct in the device's settings.</li> <li>2. Reboot the camera.</li> </ol>

## DW SPECTRUM SYSTEM REQUIREMENTS

### Recommended specs for the full client

	Minimum	Recommended
Processor	Intel i5 8th gen processor (or higher)	Intel Core i7 8th gen processor (or higher)
System RAM	8GB RAM	16GB RAM
Video card	Integrated Intel graphics	GeForce GTX 1650 or better
Network interface	2 x 1 Gbps	2 x 1 Gbps
OS Drive	256GB HDD	Dedicated 256GB SSD or larger

OS supported	<p><b>Microsoft Windows OS</b> (supported by both DW Spectrum® Server and Client).</p> <ul style="list-style-type: none"> <li>• Windows 10</li> <li>• Windows 11</li> <li>• Windows Server 2016</li> <li>• Windows Server 2019</li> <li>• Windows Server 2022</li> </ul> <p>**NOTE: DW Spectrum for Windows can be installed as a software bundle, or the Server and Client software can be installed separately.</p>
	<p><b>Ubuntu (Debian-based Linux) OS</b> (supported by both DW Spectrum Server and Client).</p> <ul style="list-style-type: none"> <li>• Ubuntu 18.04 LTS "Bionic Beaver"</li> <li>• Ubuntu 20.04 LTS: "Focal Fossa"</li> <li>• Ubuntu 22.04 LTS: "Jammy Jellyfish"</li> </ul> <p>**NOTE: DW Spectrum for Ubuntu is only available for separate installations (not bundled).</p>
	<p><b>Macintosh OS</b> (supported only by the DW Spectrum Client. DW Spectrum Server is unavailable for macOS).</p> <ul style="list-style-type: none"> <li>• macOS 11.0, 11.1, 11.2 "Big Sur"</li> <li>• macOS 12 "Monterey"</li> <li>• macOS 12 "Monterey"</li> <li>• macOS 12 "Monterey"</li> </ul> <p>**NOTE: DW Spectrum for macOS is only supported by the DW Spectrum Client.</p>

\* Except Storage Server version

Important: OS not listed will not be supported by DW® Tech Support.

Tel: +1 (866) 446-3595  
Fax: (813) 888-9262



[www.digital-watchdog.com](http://www.digital-watchdog.com)  
[sales@digital-watchdog.com](mailto:sales@digital-watchdog.com)

Copyright © Digital Watchdog. All rights reserved.  
Specifications and pricing are subject to change without notice.